



DECADES AHEAD[®]
high power RF devices

Werlatone[®], Inc.

17 Jon Barrett Road Patterson, New York 12563
 T (845) 278 2220 www.werlatone.com
 F (845) 278 3440 sales@werlatone.com



16-Way *Radial* Combiner/Divider

Model D9706

Frequency: 2700 - 3500 MHz

Power: 6000 W CW
 32 kW Peak

Insertion Loss: 0.35 dB Max.

VSWR: 1.35:1 Max.

Phase Balance: $\pm 5^\circ$ Max.

Amplitude Balance: 0.3 dB Max.

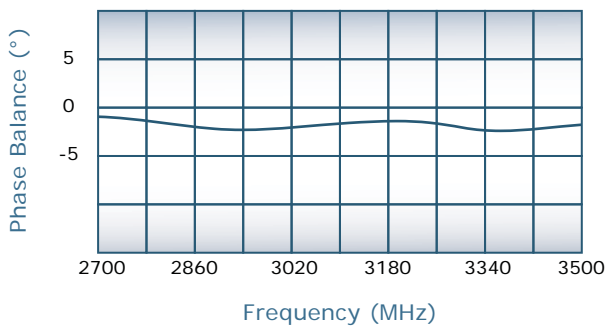
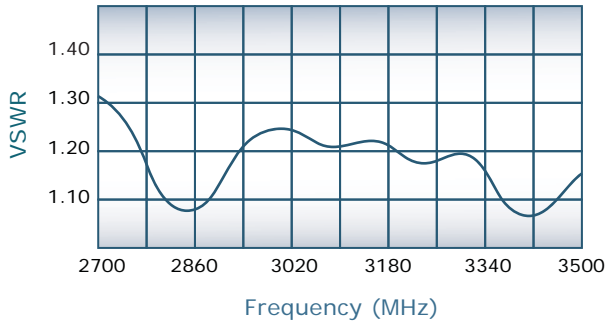
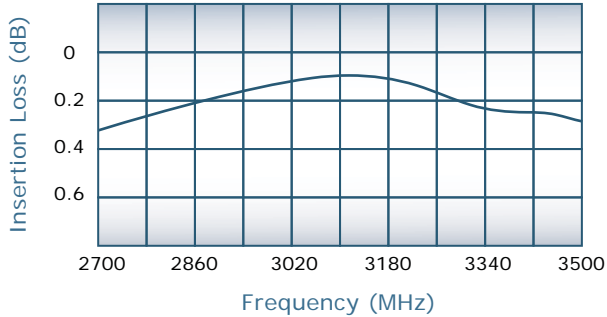

Notes

- All specifications guaranteed
- Test data provided with each unit shipped
- Alternate connector configurations upon request

[View Audiovisual Presentation](#)

Connector Configurations

Model	J17 (Sum Port)	J1-J16 (Input/Output)
D9706-WG10	WR284	N Female
D9706-WG10RA	WR284	Rt. Angle N Female

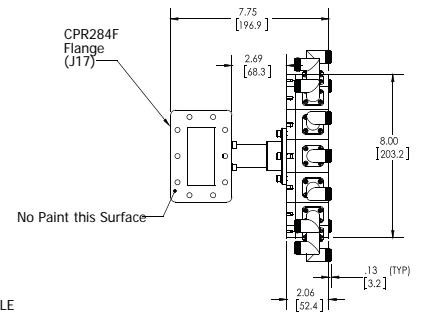
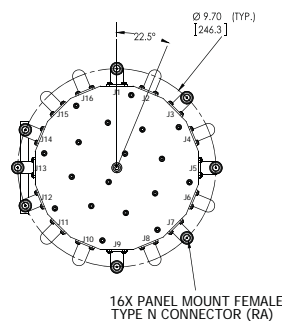
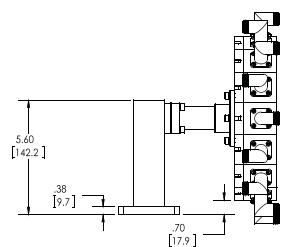
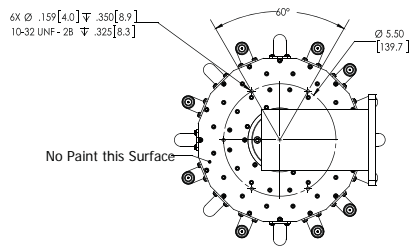

SINCE 1965

