



DECADES AHEAD[®]
high power RF devices

Werlatone[®], Inc.

17 Jon Barrett Road Patterson, New York 12563
T (845) 278 2220 www.werlatone.com
F (845) 278 3440 sales@werlatone.com



Absorptive UHF Low Pass Filter

Model AF9350

Frequency:	10 - 500 MHz
Power:	
Pass Band:	400 W CW
Stop Band:	25 W CW
Insertion Loss:	
Pass Band:	0.5 dB Max.
Rejection:	
750-3000 MHz:	45 dB Min.
VSWR:	
10-500 MHz:	1.25:1 Max.
501-1500 MHz:	1.50:1 Max.

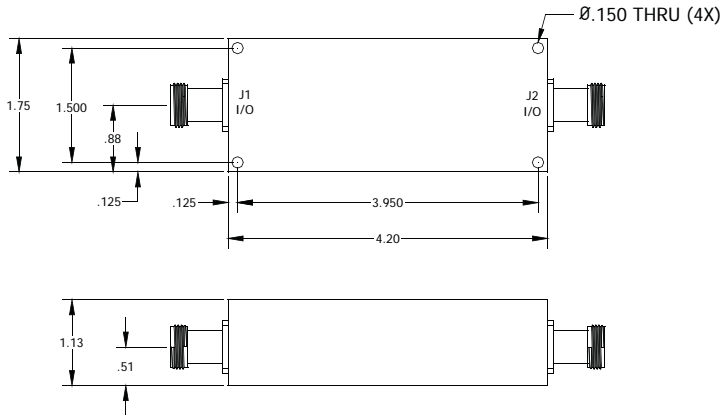

Connector Configurations

Model	J1 (Input/Output)	J2 (Input/Output)
AF9350-10	N Female	N Female
AF9350-12	N Female	SMA
AF9350-102	SMA	SMA

Notes

- All specifications guaranteed
- Test data provided with each unit shipped
- Operating Temperature: -55°C to +75°C

Insertion Loss & Band Rejection:

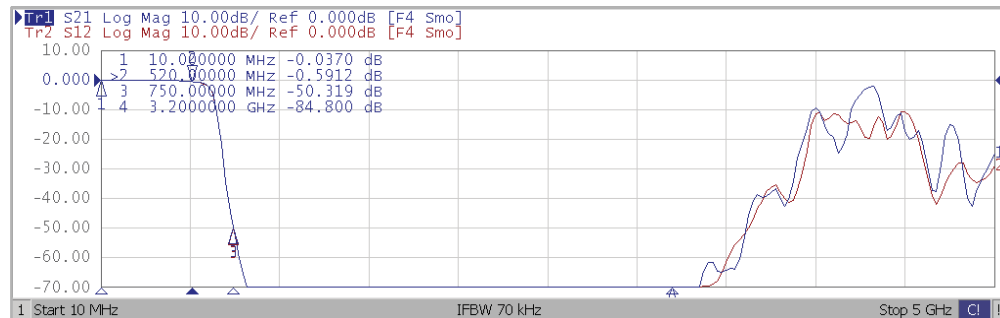

Return Loss:

